

# KOHLER® Command PRO

EN  
DE

CH940-CH1000  
CV940-CV1000  
Owner's Manual

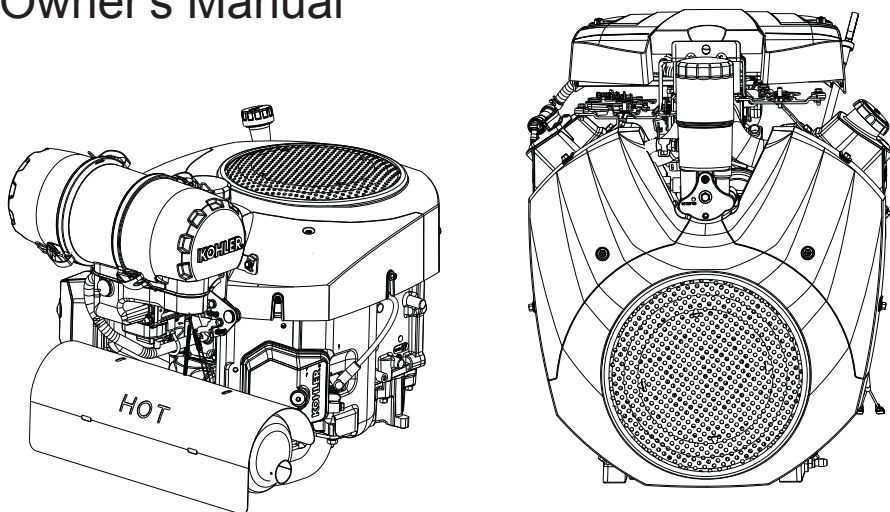

---

**IMPORTANT:** Read all safety precautions and instructions carefully before operating equipment. Refer to operating instruction of equipment that this engine powers.

Ensure engine is stopped and level before performing any maintenance or service.

Warranty coverage as outlined in the warranty card and on KohlerEngines.com. Please review carefully as it provides you specific rights and obligations.

To maintain compliance with applicable emission regulations, exhaust system backpressure may not exceed limits which can be found on KohlerEngines.com. Search by Model No., select Read More, then select Specs tab.

---

Record engine information to reference when ordering parts or obtaining warranty coverage.

Engine Model \_\_\_\_\_

Specification \_\_\_\_\_

Serial Number \_\_\_\_\_

Purchase Date \_\_\_\_\_

## Safety Precautions

**⚠ WARNING:** A hazard that could result in death, serious injury, or substantial property damage.

**⚠ CAUTION:** A hazard that could result in minor personal injury or property damage.

NOTE: is used to notify people of important installation, operation, or maintenance information.

	<p><b>⚠ WARNING</b></p> <p>Explosive Fuel can cause fires and severe burns.</p> <p>Do not fill fuel tank while engine is hot or running.</p>
	<p>Gasoline is extremely flammable and its vapors can explode if ignited. Store gasoline only in approved containers, in well ventilated, unoccupied buildings, away from sparks or flames. Spilled fuel could ignite if it comes in contact with hot parts or sparks from ignition. Never use gasoline as a cleaning agent.</p>

	<p><b>⚠ WARNING</b></p> <p>Carbon Monoxide can cause severe nausea, fainting or death.</p> <p>Avoid inhaling exhaust fumes.</p>
	<p>Engine exhaust gases contain poisonous carbon monoxide. Carbon monoxide is odorless, colorless, and can cause death if inhaled.</p>

	<p><b>⚠ WARNING</b></p> <p>Accidental Starts can cause severe injury or death.</p> <p>Disconnect and ground spark plug lead(s) before servicing.</p>
	<p>Before working on engine or equipment, disable engine as follows: 1) Disconnect spark plug lead(s). 2) Disconnect negative (-) battery cable from battery.</p>

	<p><b>⚠ WARNING</b></p> <p>Rotating Parts can cause severe injury.</p> <p>Stay away while engine is in operation.</p>
	<p>Keep hands, feet, hair, and clothing away from all moving parts to prevent injury. Never operate engine with covers, shrouds, or guards removed.</p>

	<p><b>⚠ CAUTION</b></p> <p>Electrical Shock can cause injury.</p> <p>Do not touch wires while engine is running.</p>
-----------------------------------------------------------------------------------	----------------------------------------------------------------------------------------------------------------------

	<p><b>⚠ WARNING</b></p> <p>Hot Parts can cause severe burns.</p> <p>Do not touch engine while operating or just after stopping.</p>
	<p>Never operate engine with heat shields or guards removed.</p>

### California Proposition 65 Warning

Engine exhaust from this product contains chemicals known to State of California to cause cancer, birth defects, or other reproductive harm.

### California Proposition 65 Warning

This product contains chemicals known to State of California to cause cancer, birth defects, or other reproductive harm.

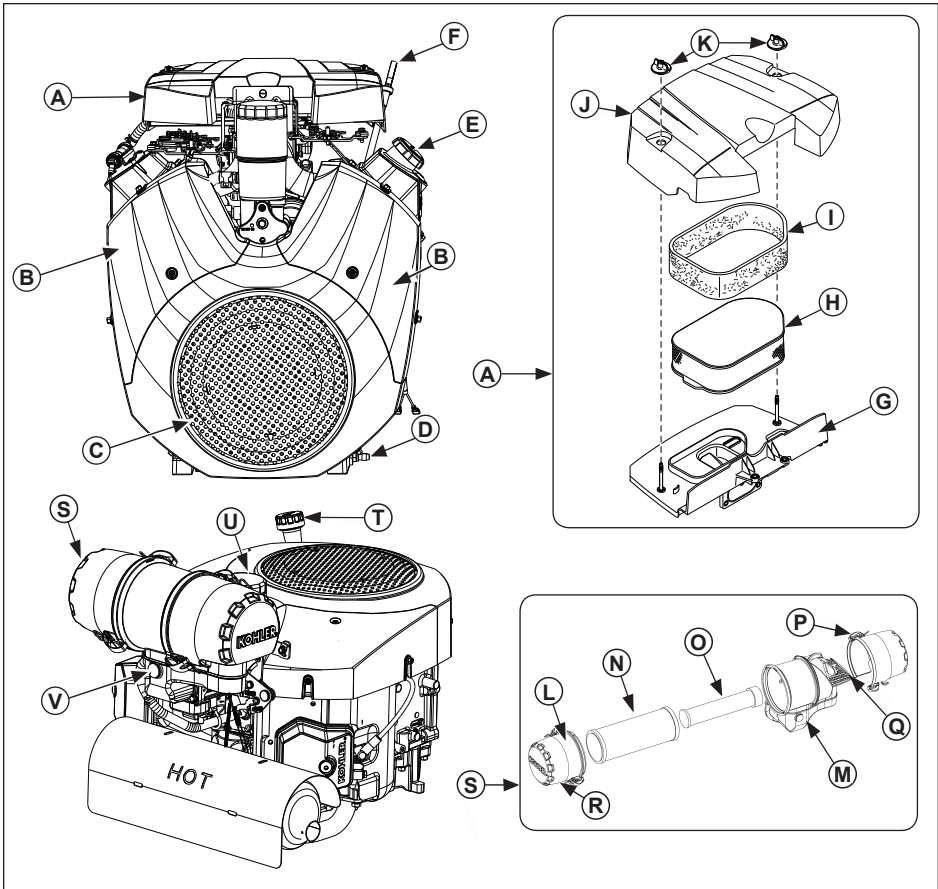

<b>A</b>	Low-Profile Air Cleaner	<b>B</b>	Cylinder Shroud	<b>C</b>	Debris Screen	<b>D</b>	Oil Drain Plug
<b>E</b>	Oil Fill	<b>F</b>	Dipstick	<b>G</b>	Air Cleaner Base	<b>H</b>	Paper Element
<b>I</b>	Precleaner	<b>J</b>	Air Cleaner Cover	<b>K</b>	Air Cleaner Knob	<b>L</b>	End Cap
<b>M</b>	Air Cleaner Housing	<b>N</b>	Element	<b>O</b>	Inner Element	<b>P</b>	Retaining Clip
<b>Q</b>	Inlet Screen	<b>R</b>	Ejector Area	<b>S</b>	Heavy-Duty Air Cleaner	<b>T</b>	Oil Fill/Dipstick
<b>U</b>	Oil Filter	<b>V</b>	Filter Minder				

### Pre-Start Checklist

1. Check oil level. Add oil if low. Do not overfill.
2. Check fuel level. Add fuel if low. Check fuel system components and lines for leaks.
3. Check and clean cooling areas, air intake areas and external surfaces of engine (particularly after storage).
4. Check that air cleaner components and all shrouds, equipment covers, and guards are in place and securely fastened.
5. Check spark arrestor (if equipped).

## Starting



### **WARNING**

Carbon Monoxide can cause severe nausea, fainting or death. Avoid inhaling exhaust fumes.

Engine exhaust gases contain poisonous carbon monoxide. Carbon monoxide is odorless, colorless, and can cause death if inhaled.



### **WARNING**

Rotating Parts can cause severe injury. Stay away while engine is in operation.

Keep hands, feet, hair, and clothing away from all moving parts to prevent injury. Never operate engine with covers, shrouds, or guards removed.

**NOTE:** Do not crank engine continuously for more than 10 seconds. Allow a 60 second cool down period between starting attempts. Failure to follow these guidelines can burn out starter motor.

**NOTE:** Upon start-up, a metallic ticking may occur. Run engine for 5 minutes. If noise continues, run engine at mid throttle for 20 minutes. If noise persists, take engine to your local Kohler authorized dealer.

1. Place throttle control midway between slow and fast positions. Place choke control into ON position.
2. Turn key switch to START position. Release switch as soon as engine starts. If starter does not turn engine over, shut off key switch immediately. Do not make further attempts to start engine until condition is corrected. Do not jump start. See your Kohler authorized dealer for trouble analysis.
3. Cold engine: Gradually return choke control to OFF position after engine starts and warms up. Engine/equipment may be operated during warm-up period, but it may be necessary to leave choke partially on until engine warms up.

Warm engine: return choke to OFF position as soon as engine starts.

## Cold Weather Starting Hints

1. Use proper oil for temperature expected.
2. Disengage all possible external loads.
3. Use fresh winter grade fuel. Winter grade fuel has higher volatility to improve starting.

## Stopping

1. If possible, remove load by disengaging all PTO driven attachments.
2. Position throttle control between half and full throttle; stop engine.

## Angle of Operation

Refer to operating instructions of equipment this engine powers. Do not operate this engine exceeding maximum angle of operation; see specification table. Engine damage could result from insufficient lubrication.

## Engine Speed



**NOTE:** Do not tamper with governor setting to increase maximum engine speed. Overspeed is hazardous and will void warranty.

## High Altitude Operation

This engine may require a high altitude carburetor kit to ensure correct engine operation at altitudes above 4000 ft. (1219 meters). To obtain high altitude kit information or to find a Kohler authorized dealer visit [KohlerEngines.com](http://KohlerEngines.com) or call 1-800-544-2444 (U.S. and Canada).

This engine should be operated in its original configuration below 4000 ft. (1219 meters) as damage may occur if high altitude carburetor kit is installed and operated below 4000 ft. (1219 meters).

## Maintenance Instructions

	 <b>WARNING</b>	Before working on engine or equipment, disable engine as follows: 1) Disconnect spark plug lead(s). 2) Disconnect negative (-) battery cable from battery.
	Accidental Starts can cause severe injury or death. Disconnect and ground spark plug lead(s) before servicing.	

Normal maintenance, replacement or repair of emission control devices and systems may be performed by any repair establishment or individual; however, warranty repairs must be performed by a Kohler authorized dealer found at KohlerEngines.com or 1-800-544-2444 (U.S. and Canada).

## Maintenance Schedule

### Weekly

- Check filter minder.

### Every 25 Hours or Annually<sup>1</sup>

- Service/replace low-profile precleaner.

### Every 100 Hours or Annually<sup>1</sup>

- Change oil. Oil filter is recommended.

### Every 150 Hours<sup>1</sup>

- Replace low-profile air cleaner element.
- Remove cooling shrouds and clean cooling areas.

### Every 150 Hours

- Check heavy-duty air cleaner element.
- Replace fuel filter.
- Check oil cooler fins, clean as necessary.

### Every 200 Hours

- Change oil filter.

### Every 300 Hours

- Replace heavy-duty air cleaner element.

### Every 500 Hours or Annually<sup>1</sup>

- Replace spark plugs and set gap.

### Every 500 Hours<sup>2</sup>

- Have crankshaft splines lubricated.

### Every 600 Hours

- Replace heavy-duty inner air cleaner element.

<sup>1</sup> Perform these procedures more frequently under severe, dusty, dirty conditions.

<sup>2</sup> Have a Kohler authorized dealer perform this service.

## Oil Recommendations

We recommend use of Kohler oils for best performance. Other high-quality detergent oils (including synthetic) of API (American Petroleum Institute) service class SJ or higher are acceptable. Select viscosity based on air temperature at time of operation as shown in table below.

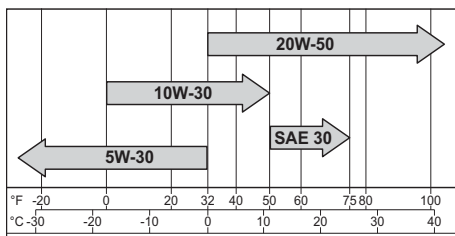

## Check Oil Level

**NOTE:** To prevent extensive engine wear or damage, never run engine with oil level below or above operating range indicator on dipstick.

Ensure engine is cool. Clean oil fill/dipstick areas of any debris.

1. Remove dipstick; wipe oil off.
  - a. Press-in cap: reinsert dipstick into tube; press completely down.  
or
  - b. Thread-on cap: reinsert dipstick into tube; rest cap on tube, do not thread cap onto tube.
2. Remove dipstick; check oil level. Level should be at top of indicator on dipstick.

- If oil is low on indicator, add oil up to top of indicator mark.
- Reinstall and secure dipstick.

### Change Oil and Filter



Change oil while engine is warm.

- Clean area around oil fill cap/dipstick and drain plug. Remove drain plug and oil fill cap/dipstick. Allow oil to drain completely.
- Clean area around oil filter; remove filter; wipe off mounting surface. Reinstall drain plug. Torque to 15.7 ft. lb. (21.4 N·m).
- Place new filter in shallow pan with open end up. Fill with new oil until oil reaches bottom of threads. Allow 2 minutes for oil to be absorbed by filter material.
- Apply a thin film of clean oil to rubber gasket on new filter.
- Refer to instructions on oil filter for proper installation.
- Fill crankcase with new oil. Level should be at top of indicator on dipstick.
- Reinstall oil fill cap/dipstick and tighten securely.
- Start engine; check for oil leaks. Stop engine; correct leaks. Recheck oil level.
- Dispose of used oil and filter in accordance with local ordinances.

### Oil Sentry™ (if equipped)

This switch is designed to prevent engine from starting in a low oil or no oil condition. Oil Sentry™ may not shut down a running engine before damage occurs. In some applications this switch may activate a warning signal. Read your equipment manuals for more information.

### Fuel Recommendations

	 <b>WARNING</b>
	<p>Explosive Fuel can cause fires and severe burns.</p> <p>Do not fill fuel tank while engine is hot or running.</p>
<p>Gasoline is extremely flammable and its vapors can explode if ignited. Store gasoline only in approved containers, in well ventilated, unoccupied buildings, away from sparks or flames. Spilled fuel could ignite if it comes in contact with hot parts or sparks from ignition. Never use gasoline as a cleaning agent.</p>	

NOTE: E15, E20 and E85 are NOT approved and should NOT be used; effects of old, stale or contaminated fuel are not warrantable.



Fuel must meet these requirements:

- Clean, fresh, unleaded gasoline.
- Octane rating of 87 (R+M)/2 or higher.
- Research Octane Number (RON) 90 octane minimum.
- Gasoline up to 10% ethyl alcohol, 90% unleaded is acceptable.
- Methyl Tertiary Butyl Ether (MTBE) and unleaded gasoline blend (max 15% MTBE by volume) are approved.
- Do not add oil to gasoline.
- Do not overfill fuel tank.
- Do not use gasoline older than 30 days.

### Fuel Line

Low permeation fuel line must be installed on carbureted Kohler Co. engines to maintain EPA and CARB regulatory compliance.

## Spark Plugs

	 <b>CAUTION</b>
	<p>Electrical Shock can cause injury. Do not touch wires while engine is running.</p>

Clean out spark plug recess. Remove plug and replace.

1. Check gap using wire feeler gauge. Adjust gap, see specification table for adjustment.
2. Install plug into cylinder head.
3. Torque plug to 20 ft. lb. (27 N·m).

## Air Cleaner

**NOTE:** Operating engine with loose or damaged air cleaner components could cause premature wear and failure. Replace all bent or damaged components.

**NOTE:** Paper element cannot be blown out with compressed air.

### Low-Profile

Loosen knobs and remove air cleaner cover.

Pre-cleaner:

1. Remove pre-cleaner from paper element.
2. Replace or wash pre-cleaner in warm water with detergent. Rinse and allow to air dry.
3. Saturate pre-cleaner with new engine oil; squeeze out excess oil.
4. Reinstall pre-cleaner over paper element.

Paper Element:

1. Remove paper element with pre-cleaner.
2. Separate pre-cleaner from element; service pre-cleaner and replace paper element.
3. Install new paper element on base; install pre-cleaner over paper element.

Reinstall air cleaner cover and secure with knobs.

### Heavy-Duty

1. Unhook retaining clips and remove end cap(s).
2. Check and clean inlet screen (if equipped).
3. Pull air cleaner element out of housing and replace. Check condition of inner element; replace when dirty.
4. Check all parts for wear, cracks, or damage, and that ejector area is clean.
5. Install new element(s).
6. Reinstall end cap(s) with dust ejector valve/screen down; secure with retaining clips.

## Breather Tube



Ensure both ends of breather tube are properly connected.

## Oil Cooler

**NOTE:** Oil cooler is mounted under cylinder shroud. Removal of cylinder shroud is necessary to access oil cooler.

1. Clean fins with a brush or compressed air.
2. Remove two screws securing oil cooler, and tilt to clean back side.
3. Reinstall oil cooler.

## Air Cooling

	 <b>WARNING</b>
	<p>Hot Parts can cause severe burns. Do not touch engine while operating or just after stopping.</p>
<p>Never operate engine with heat shields or guards removed.</p>	

Proper cooling is essential. To prevent over heating, clean screens, cooling fins, and other external surfaces of engine. Avoid spraying water at wiring harness or any electrical components. See Maintenance Schedule.

## Repairs/Service Parts

We recommend that you use a Kohler authorized dealer for all maintenance, service, and replacement parts for engine. To find a Kohler authorized dealer visit [KohlerEngines.com](http://KohlerEngines.com) or call 1-800-544-2444 (U.S. and Canada).

## Storage

If engine will be out of service for 2 months or more follow procedure below.

1. Add Kohler PRO Series fuel treatment or equivalent to fuel tank. Run engine 2-3 minutes to get stabilized fuel into fuel system (failures due to untreated fuel are not warrantable).
2. Change oil while engine is still warm from operation. Remove spark plug(s) and pour about 1 oz. of engine oil into cylinder(s). Replace spark plug(s) and crank engine slowly to distribute oil.
3. Disconnect negative (-) battery cable.
4. Store engine in a clean, dry place.

## Troubleshooting

Do not attempt to service or replace major engine components, or any items that require special timing or adjustment procedures. This work should be performed by a Kohler authorized dealer.

Problem	Possible Cause							
	No Fuel	Improper Fuel	Dirt In Fuel Line	Dirty Debris Screen	Incorrect Oil Level	Engine Overloaded	Dirty Air Cleaner	Faulty Spark Plug
Will Not Start	•	•	•		•	•	•	•
Hard Starting		•	•		•	•	•	•
Stops Suddenly	•		•	•	•	•	•	•
Lacks Power		•	•	•	•	•	•	•
Operates Erratically		•	•	•		•	•	•
Knocks or Pings		•		•		•		•
Skips or Misfires		•	•	•			•	•
Backfires		•	•			•	•	•
Overheats		•	•	•	•	•	•	
High Fuel Consumption						•	•	•

## Engine Specifications

Model	Bore	Stroke	Displacement	Oil Capacity (Refill)	Spark Plug Gap	Maximum Angle of Operation (@ full oil level)*
CV940	3.54 in. (90 mm)	3.1 in. (78.5 mm)	61 cu. in. (999 cc)	2 U.S. qt. (1.9 L)	0.03 in. (0.76 mm)	25°
CV960						
CV980						
CV1000						
CH940						
CH960						
CH980						
CH1000						

\*Exceeding maximum angle of operation may cause engine damage from insufficient lubrication.

Additional specification information can be found in service manual at [KohlerEngines.com](http://KohlerEngines.com).

Exhaust Emission Control System for models CH940-CH1000 and CV940-CV1000 is EM for U.S. EPA, California, and Europe.

Any and all horsepower (hp) references by Kohler are Certified Power Ratings and per SAE J1940 & J1995 hp standards. Details on Certified Power Ratings can be found at [KohlerEngines.com](http://KohlerEngines.com).